



DIECI



PEGASUS 400°



38.16
400°



40.18
400°

PERFORMANCE		
Machine model	PEGASUS 38.16 - 400°	PEGASUS 40.18 - 400°
Maximum capacity	3800 kg (8378 lb)	4000 kg (8818 lb)
Maximum lifting height on outriggers	15,70 m (52 ft)	18,00 m (59 ft)
Maximum horizontal extension on outriggers	13,40 m (44 ft)	15,30 m (50 ft)
Fork swiveling angle	133°	133°
Pull-out force	5700 daN (12814 lbf)	5700 daN (12814 lbf)
Towing force	7300 daN (16411 lbf)	7300 daN (16411 lbf)
Maximum climb angle	40%	40%
Unladen weight	13200 kg (29101 lb)	13700 kg (30203 lb)
Max speed (referred to wheels with maximum permitted diameter)	26 km/h (16,2 mph)	26 km/h (16,2 mph)
BOOM		
Machine model	PEGASUS 38.16 - 400°	PEGASUS 40.18 - 400°
Lifting	17,4 s	20,6 s
Getting off the basket	12,6 s	14,2 s
Extension	34,2 s	26,0 s
Retraction	21,9 s	17,0 s
Forward swiveling	3,9 s	3,8 s
Reverse swiveling	2,4 s	2,0 s
ENGINE		
Machine model	PEGASUS 38.16 - 400°	PEGASUS 40.18 - 400°
Brand	Kubota	Kubota
Nominal power	73,4 kW (98 HP)	73,4 kW (98 HP)
@rpm	2600 rpm	2600 rpm
Operation	4-stroke	4-stroke
Injection	Electronic, Common Rail	Electronic, Common Rail
Number and arrangement of cylinders	4, Vertical in line	4, Vertical in line
Displacement	3769 cm ³ (230 in ³)	3769 cm ³ (230 in ³)
Consumption	231 g/kWh (380 lb/Hp h)	231 g/kWh (380 lb/Hp h)
@rpm	2600 rpm	2600 rpm
Emission standards	Stage IIIB/Tier 4i	Stage IIIB/Tier 4i
Exhaust gas treatment	Particulate filter (DPF)	Particulate filter (DPF)
Cooling system	Liquid	Liquid
Intake	Turbo compressor	Turbo compressor
DIFFERENTIAL AXLES		
Machine model	PEGASUS 38.16 - 400°	PEGASUS 40.18 - 400°
Axles type	2 steering, with 4 planetary reduction gears	2 steering, with 4 planetary reduction gears
Type of steering	4 wheels / transversal / 2 wheels	4 wheels / transversal / 2 wheels
Front axle	Rigid	Rigid
Rear axle	Swinging	Swinging
Service braking	Oil bath with servo brake on front and rear axle with double hydraulic system	Oil bath with servo brake on front and rear axle with double hydraulic system
Parking braking	Negative actuation with electrical control	Negative actuation with electrical control
HYDRAULIC SYSTEM		
Machine model	PEGASUS 38.16 - 400°	PEGASUS 40.18 - 400°
Hydraulic pump type	Double gear pump with "Energy Saving" system	Double gear pump with "Energy Saving" system
Hydraulic pump capacity	135 L/min (35,7 gal/min)	135 L/min (35,7 gal/min)
Max. operating pressure	23,0 MPa (3336 psi)	23,0 MPa (3336 psi)
Distributor control	Proportional 5in1 Joystick	Proportional 5in1 Joystick
Distributor type	Hydraulic in 5 sections with "Load Sensing" proportional electronic servo-control with "Flow Sharing", 5 simultaneous movements	Hydraulic in 5 sections with "Load Sensing" proportional electronic servo-control with "Flow Sharing", 5 simultaneous movements
REFUELING		
Machine model	PEGASUS 38.16 - 400°	PEGASUS 40.18 - 400°
Hydraulic system (total)	270,0 L (71,33 gal)	270,0 L (71,33 gal)
Diesel tank	180,0 L (47,55 gal)	180,0 L (47,55 gal)
TRANSMISSION		
Machine model	PEGASUS 38.16 - 400°	PEGASUS 40.18 - 400°
Transmission type	Hydrostatic with variable flow pump	Hydrostatic with variable flow pump
Hydraulic motor	Hydrostatic with continuous automatic adjustment	Hydrostatic with continuous automatic adjustment
Reversal	Electrohydraulic	Electrohydraulic
Inching	With inching pedal for controlled forward movement	With inching pedal for controlled forward movement
Transmission gearbox	Servocontrolled 2-speed	Servocontrolled 2-speed
TIRES		
Machine model	PEGASUS 38.16 - 400°	PEGASUS 40.18 - 400°
Standard tires	400/70x20"	400/70x20"
Optional tires	400/70R20"	400/70R20"

DIMENSIONS

Machine model	PEGASUS 38.16 - 400°	PEGASUS 40.18 - 400°
A	310 mm (12,2 in)	310 mm (12,2 in)
B	2430 mm (95,7 in)	2280 mm (89,8 in)
C	2950 mm (116,1 in)	2950 mm (116,1 in)
D	1175 mm (46,3 in)	1175 mm (46,3 in)
E	1490 mm (58,7 in)	1330 mm (52,4 in)
F	4880 mm (192,1 in)	4880 mm (192,1 in)
G	6740 mm (265,4 in)	6630 mm (261 in)
H	3035 mm (119,5 in)	3035 mm (119,5 in)
I	980 mm (38,6 in)	980 mm (38,6 in)
L	1920 mm (75,6 in)	1920 mm (75,6 in)
M	2380 mm (93,7 in)	2380 mm (93,7 in)
N	3968 mm (156,2 in)	3968 mm (156,2 in)
O	5163 mm (203,3 in)	5163 mm (203,3 in)
P	1700 mm (66,9 in)	1700 mm (66,9 in)
Q	4430 mm (174,4 in)	4430 mm (174,4 in)
R	4750 mm (187 in)	4750 mm (187 in)
S	2420 mm (95,3 in)	2420 mm (95,3 in)
T	200 mm (7,9 in)	140 mm (5,5 in)

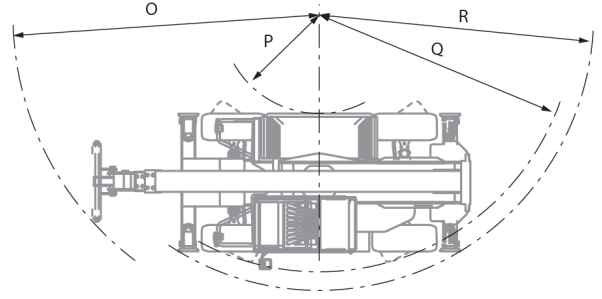
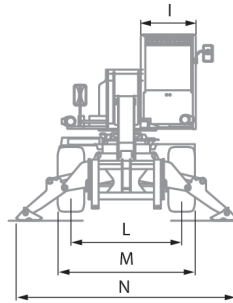
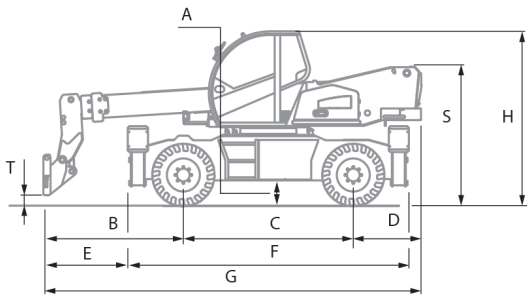

MAX 2,3 t

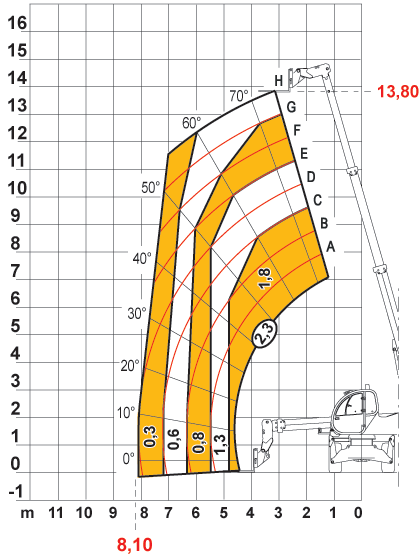

AXBI487



EN1459

38.16 - 400°

MAX 1,8 t

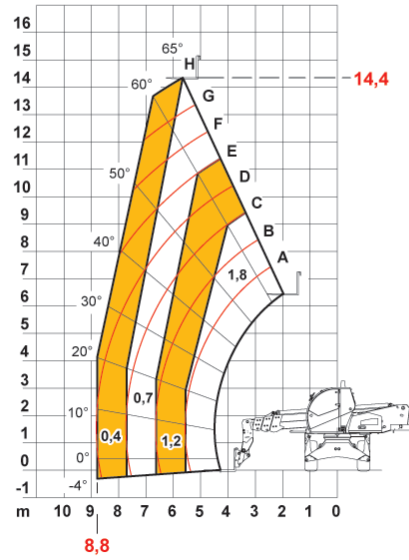

AXBI508



EN1459

40.18 - 400°

MAX 3,8 t

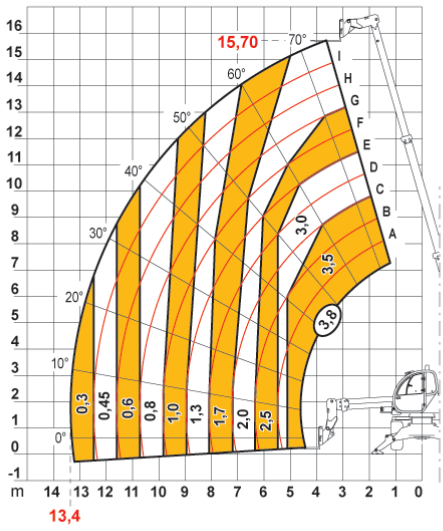

AXBI487-I



EN1459

38.16 - 400°

MAX 4,0 t

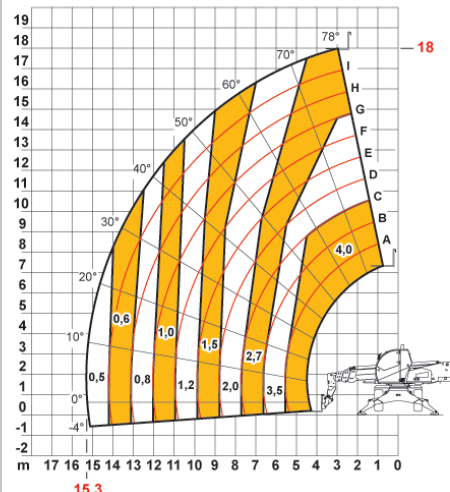

AXBI508/I



EN1459

40.18 - 400°

MAX 3,2 t

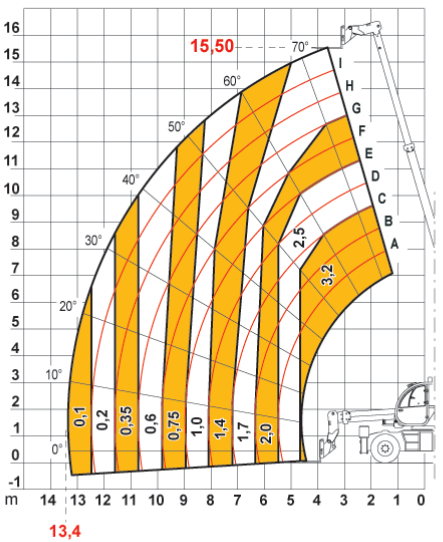

AXBI487-I2



EN1459

38.16 - 400°

MAX 3,5 t

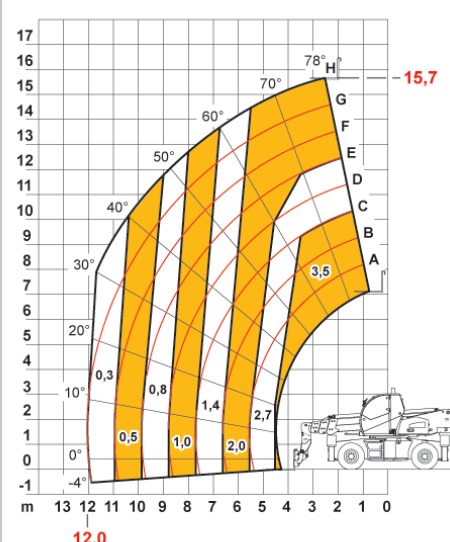

AXBI508/I2



EN1459

40.18 - 400°